

RECOMMENDED CONNECTOR MOUNTING HOLE PATTERN  
(CONNECTOR SIDE SHOWN)

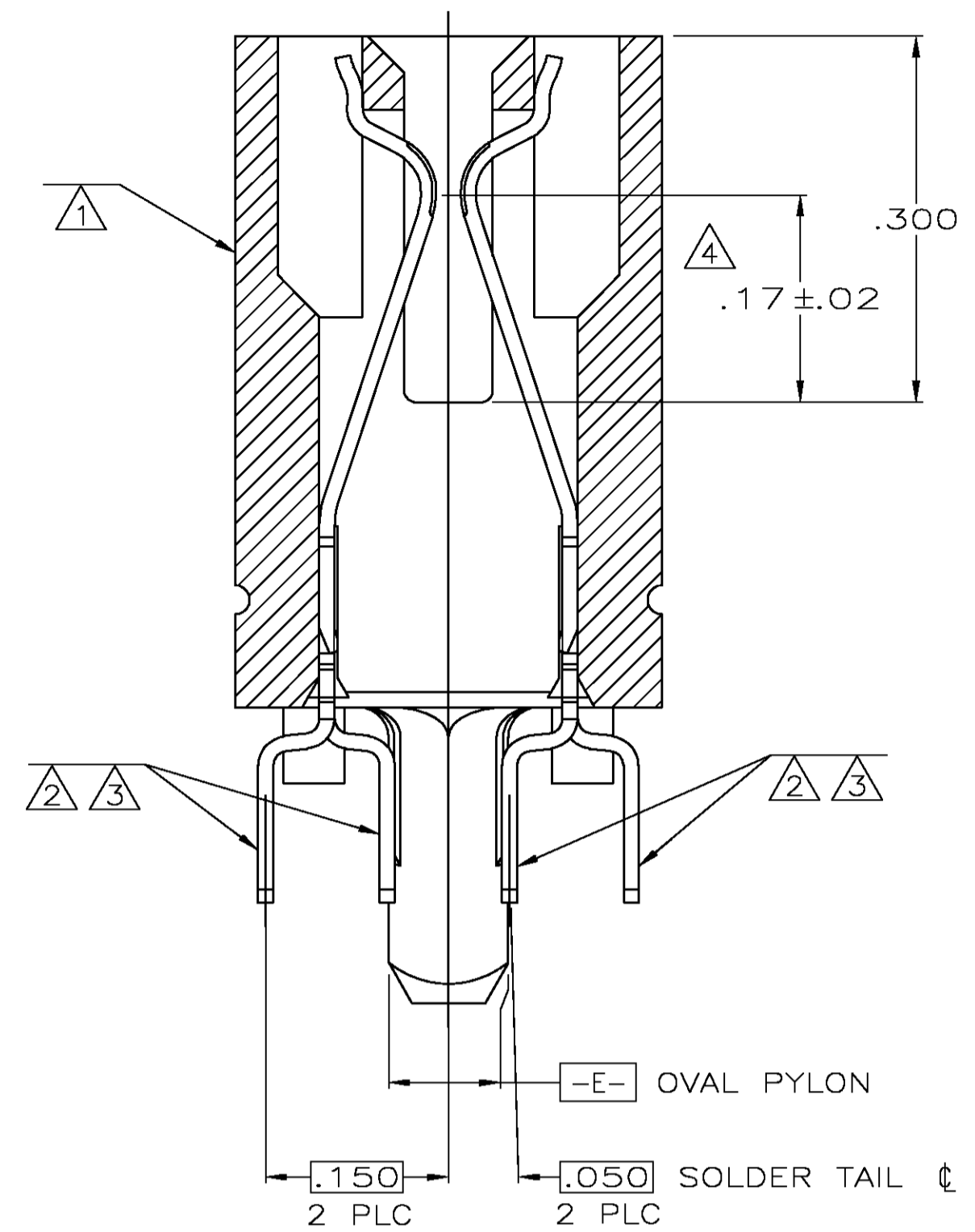

SECTION L-L  
SCALE 8:1

- ① HOUSING: HIGH TEMPERATURE THERMOPLASTIC. COLOR: BROWN.
- ② CONTACT: PHOSPHOR BRONZE.
- ③ CONTACT FINISH: .000100 MIN NICKEL ALL OVER. .000030 MIN GOLD OVER NICKEL IN CONTACT AREA. .000100 MIN TIN-LEAD OVER NICKEL ON SOLDER TAILS.
- ④ DISTANCE FROM CONTACT POINT TO BOTTOM OF CARD SLOT.
- ⑤ AMP PART NUMBER, DATE CODE AND CSA LOGO MARKED IN APPROXIMATE AREA SHOWN.

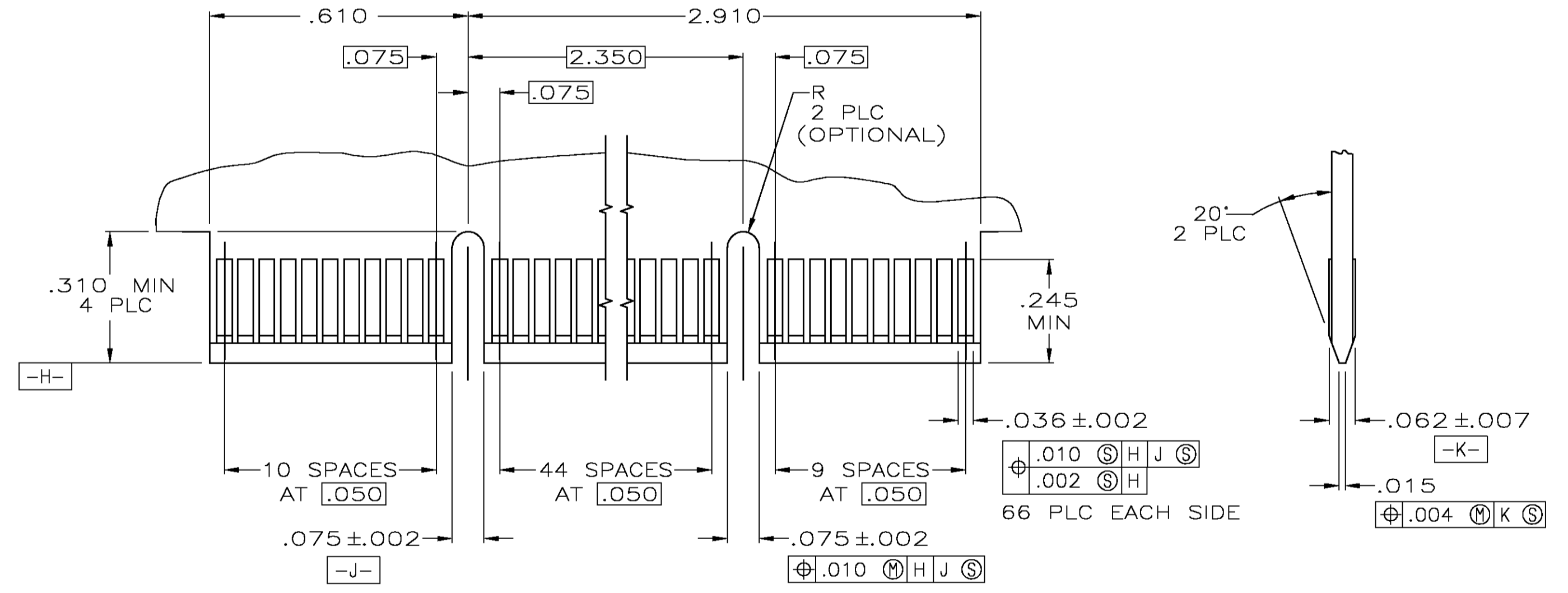

RECOMMENDED MATING BOARD EDGE CONFIGURATION

OBSOLETE	.125	650091-3
	.14	650091-2
OBSOLETE	.10	650091-1
	W	PART NUMBER

THIS DRAWING IS A CONTROLLED DOCUMENT.		DWN K.L.CLOUSER/UTA 3/21/91	Tyco Electronics Corporation Harrisburg, Pa 17105-3608	
DIMENSIONS: mm		CHK M.BOWERS	APVD	
TOLERANCES UNLESS OTHERWISE SPECIFIED:		PRODUCT SPEC 108-14034		
0 PLC ± -		APPLICATION SPEC 114-26012		
1 PLC ± .01		SIZE A1		
2 PLC ± .01		CAGE CODE 00779		
3 PLC ± .005		DRAWING NO 650091		
4 PLC ± -		RESTRICTED TO		
ANGLES ± ±		CUSTOMER DRAWING		
FINISH		SCALE 4:1 SHEET 1 OF 1 REV K		